

Freestanding STOVE K7

KOZA/K7

EAN:

5901350039670

Stove fits perfectly into the stylish interiors, an excellent solution for those who appreciate the traditional style.



Technical Specifications

Rated output (kW)	5,0
Range of heating power (kW)	3.0 - 8.0
Efficiency (%)	71,0
Exhaust outlet diameter (mm)	130
Complies with Ecodesign criteria	No
Designed for heat recovery unit	No
Fuel type	recommended seasoned hardwood with moisture $\leq 20\%$
Weight (kg)	75,0
CO emission (at 13% O ₂) \leq given in %	0,30
Flue gas temperature (°C)	340,0
Max log length (cm)	30
Emission of dust (mg/Nm ³)	187,0
Compliance with BImSchV 2 standard	No
The energy efficiency index EEI	93,66
Glazing type	straight
Opening of the doors	to the left
Material	cast iron
Width (cm)	53,60

Height (cm)	55,70
Depth (cm)	41,30
External air inlet	No
The liner of the combustion chamber	No
Ashpan	Yes
Decorative printed glass	No
ASDP - automatic control of the air supply	No
Turbine TURBOFAN	No
Water panel	No

Features

MAXIMUM USE OF ENERGY

Maximum use of heat and trouble-free operation thanks to the walls of the device made of high quality cast iron with a thickness of 8 mm.

Combustion of fuel particles thanks to deflector, which extends the exhaust gas path.

Manual control of the combustion process through the ashpan.

SAFETY AT THE HIGHEST LEVEL

Classic front of insert is equipped with a heat-resistant ceramics that can withstand temperatures up to 800oC.

Decorative fence helps to maintain the tidiness and protects against falling out of wood.

CONVENIENT TO USE

The cold handle system allows to disassembly it when the stove is in use.

Ash drawer / ashtray, where the remains of burnt wood are gathered and grate for easy ash removal.

Reduced soot deposition through a system of pure glass (air curtain).

The possibility of different assembly, thanks to the adjustable outlet of flue gas from the back or top of the stove.

5 year warranty.

Technical drawing

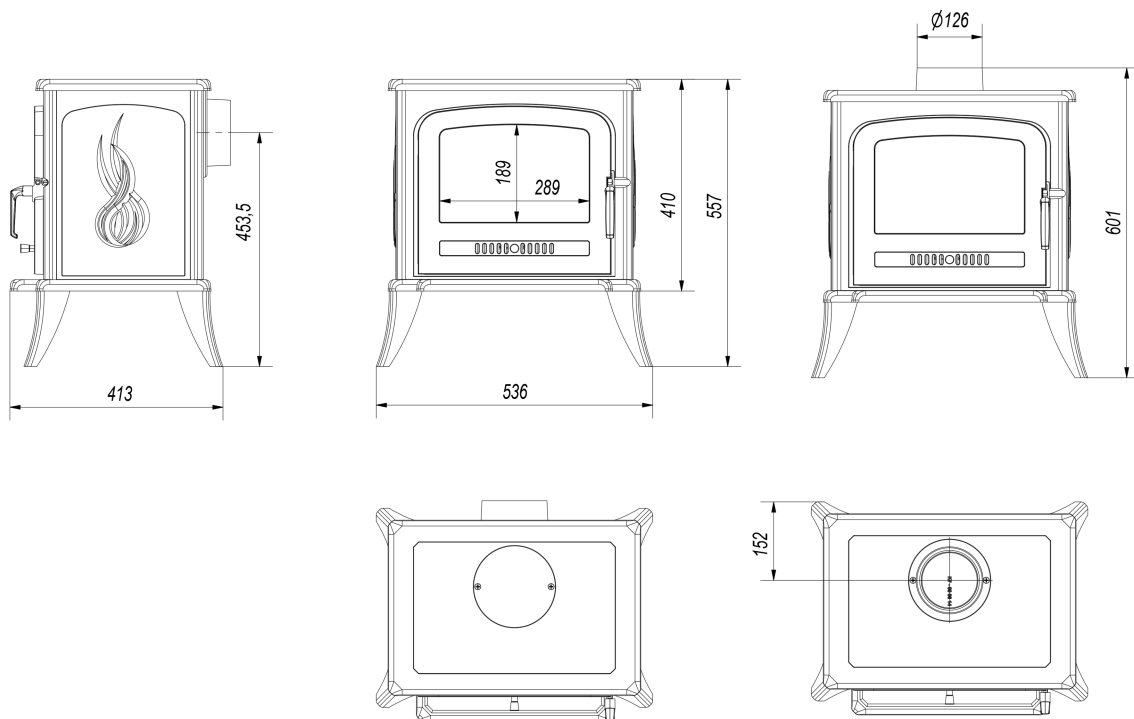

Additional options



Decorative openwork "M" for stoves

50,00 zł

Decorative openwork "M" for freestanding stoves K7.



Decorative openwork "VV" for stoves

50,00 zł

Decorative openwork "VV" for freestanding stoves K7.



Steel pipe 130/1m

84,00 zł

Exhaust pipe designed for connecting wood-fired fireplace inserts an the existing flue pipes.



Steel pipe 130/0.5m

58,00 zł

Exhaust pipe designed for connecting wood-fired fireplace inserts an the existing flue pipes.



Movable elbow 130/90

88,00 zł

Adjustable elbow up to 90°, 3-segment, diameter: 130 mm.



Damper Ø 130 black

The damper is designed to regulate the smoke draft.

88,00 zł



Steel rosette Ø 130

Rosette Ø 130, made of black sheet - a masking element.

16,00 zł

Warranty

Wszystkie produkty dostępne na www.kratki.com są fabrycznie nowe, wolne od wad fizycznych i prawnych oraz zostały legalnie wprowadzone na rynek polski. Producent udziela 5 lat gwarancji od momentu zakupu pieca na jego sprawne działanie. Ruszt i uszczelnienia kominka objęte są gwarancją na okres 1 roku od momentu zakupu pieca. Gwarancją nie jest objęta: ceramika żaroodporna. Zastosowanie pieca wolnostojącego, sposób podłączenia do komina oraz warunki eksploatacji muszą być zgodne z instrukcją obsługi.

Return

Klient będący Konsumentem, który zawarł Umowę sprzedaży, może w terminie 14 dni odstąpić od niej bez podawania przyczyny. Bieg terminu na odstąpienie od Umowy sprzedaży rozpoczyna się od chwili objęcia Towaru w posiadanie przez Klienta lub wskazaną przez niego osobę trzecią inną niż przewoźnik. Oświadczenie można złożyć na formularzu, którego wzór został zamieszczony przez Sprzedawcę na Stronie Internetowej Sklepu pod adresem: **formularz odstąpienia**.



Kratki.pl Marek Bal
ul. W. Gombrowicza 4
26-660 Wsola/Jedlińsk

www.kratki.com
+48 48 338 44 88

Date of publication:
07.09.2018