

Fireplace VN 610/430 left BS guillotine

VNL/610/430

The modern VN insert the up-door version (guillotine - lift up system) with side glazing without a muntin combines unique aesthetics and exceptional performance properties. In addition to visual features, the device guarantees efficient space heating and ecological wood burning.



Technical Specifications

Rated output (kW)	9,0
Range of heating power (kW)	3.5 - 11.0
Efficiency (%)	81,0
Exhaust outlet diameter (mm)	200
Complies with Ecodesign criteria	Yes
Designed for heat recovery unit	Yes
Fuel type	recommended seasoned hardwood with moisture $\leq 20\%$
Weight (kg)	204,0
CO emission (at 13% O ₂) \leq given in %	0,09
Flue gas temperature (°C)	220,0
Max log length (cm)	40
Emission of dust (mg/Nm ³)	23,0
Compliance with BlmSchV 2 standard	Yes
The energy efficiency index EEI	106,71
The minimum active field of exhaust grilles (cm ²)	≥ 700
The minimum active field of inlet grilles (cm ²)	≥ 500

Glazing type	lateral
Opening of the doors	lift up, to the right
Material	steel
Width (cm)	73,00
Height (cm)	138,90
Depth (cm)	55,00
External air inlet	Yes
The liner of the combustion chamber	Yes
Ashpan	Yes
Decorative printed glass	Yes

Features

The modern VN insert the up-door version (guillotine - lift up system) with side glazing without a muntin combines unique aesthetics and exceptional performance properties. In addition to visual features, the device guarantees efficient space heating and ecological wood burning. Thanks to the use of modern materials and innovative technical solutions, it is characterized by a very subtle appearance. One of its many advantages is the possibility of connecting the air intake from the outside. The elegance of the insert is added by the decorative Glass type glazing. In addition, it has a parental lock that protects against uncontrolled opening of the door.

SAFETY AT THE HIGHEST LEVEL

The insert ensures the safety of use, because it has so-called a parental lock, protecting against uncontrolled opening of the door.

The front of the insert is equipped with heat-resistant ceramics that withstand temperatures up to 800°C. The assembled glass has a quality and safety certificate.

The body and front of the insert are resistant to high temperatures due to the use of high-quality steel.

The door frame is made of a closed profile, which makes it stable and resistant to tensions occurring during operation at high temperatures. The excellent tightness of the insert is guaranteed by the solid welds made in the noble gas shield. Steel elements laser cut by means of modern devices, and then bent on CNC bending machines.

MODERN DESIGN

The VN insert attracts attention with its modern design and aesthetics of the finish. It impresses with a harmonious vision of fire, giving the interior a unique style. Heat radiates not only frontally, but also to the side.

The fireplace is equipped with a single, decorative Glass window, thanks to which it looks elegant and modern. The use of this solution visually enlarges the front of the cartridge and emphasizes the vision of fire.

COMFORTABLE USE

The door of the insert works in the lift up system - the window is lifted up. This system was built based on the counterweight - the steel cable pulley works in guides on two ball bearings, thanks to which the weight of the door is distributed evenly. They move on fireproof bearings along the sliding guides mounted in the frame, which guarantees their light, quiet and trouble-free operation. Movement of the door runs a few millimetres away from the body, which prevents damage to the seal. Lockable doors are pressed with great force into the frame, thanks to which the furnace is completely sealed.

Thanks to the raised and lowered door, you can load the right amount of wood at a time. An additional mechanism that allows the side windows to be opened, making them easier to clean and to keep the furnace clean.

The device is additionally equipped with a clean glass system - thanks to the so-called curtain air flow is distributed evenly, sweeps glass and minimizes the deposition of soot on it. This allows you to maintain the effective and clean look of the glass for a long time.

The fireplace has a specially profiled bottom plate made of Acumotte, thanks to which the combustion chamber is deeper and contains more wood. Maintaining the fireplace is easier due to the mounted grate and the container in which ash accumulates.

The internal revision system makes it possible to carry out service activities from the inside of the furnace without destroying the building of the fireplace.

The insert can be used in a variety of mounting conditions, thanks to adjustable feet and a movable adjustable 360° exhaust outlet.

MAXIMUM USE OF ENERGY

More efficient combustion and longer temperature maintenance is effect of Acumotte lining in combustion chamber, a heat accumulating material that increases the temperature in the furnace. In addition, its smooth, white surface looks impressive inside the fireplace.

Afterburning of fuel particles is due to two deflectors that extend the exhaust path. This process also increases the efficiency of combustion and guarantees better use of energy, and minimizes the emission of harmful substances into the atmosphere.

The insert has a horizontal flue, built in a high flue, which allows for additional heat recovery from fumes, and thus maximum energy use.

The device has a triple ventilation system for the combustion chamber, thanks to which wood burning in the insert is ecological and, most importantly, economical.

The primary air is supplied to the cartridge from the outside, thanks to the built-in 125 mm air inlet connection. The air intake stub is located in the floor of the cartridge. Its regulation takes place by built-in throttle, set by one controller below the door, which excludes errors in improper use. The whole mechanism works inside the fireplace, very quiet and trouble-free.

ECOLOGICAL COMBUSTION

The VN model meets the requirements of **Ecodesign** standards and the restrictions of the **BImSchV 2** standard, which determines the maximum CO emission.

Technical drawing

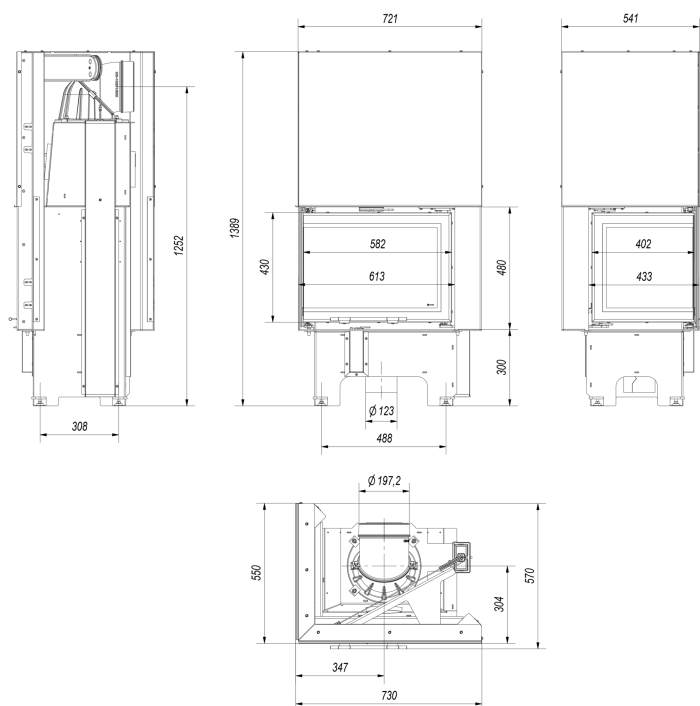

Warranty

Wszystkie produkty dostępne na www.kratki.com są fabrycznie nowe, wolne od wad fizycznych i prawnych oraz zostały legalnie wprowadzone na rynek polski. Producent udziela 5 lat gwarancji od momentu zakupu wkładu na jego sprawne działanie. Wyłożenie ceramiczne objęte jest gwarancją na okres 2 lat od momentu zakupu wkładu. Ruszt i uszczelnienia kominka objęte są gwarancją na okres 1 roku od momentu zakupu wkładu. Gwarancją nie jest objęta: ceramika żaroodporna. Zastosowanie wkładu kominkowego, sposób podłączenia do komina oraz warunki eksploatacji muszą być zgodne z instrukcją obsługi.

Return

Klient będący Konsumentem, który zawarł Umowę sprzedaży, może w terminie 14 dni odstąpić od niej bez podawania przyczyny. Bieg terminu na odstąpienie od Umowy sprzedaży rozpoczyna się od chwili objęcia Towaru w posiadanie przez Klienta lub wskazaną przez niego osobę trzecią inną niż przewoźnik. Oświadczenie można złożyć na formularzu, którego wzór został zamieszczony przez

Sprzedawcę na Stronie Internetowej Sklepu pod adresem: **formularz odstąpienia**.



Kratki.pl Marek Bal
ul. W. Gombrowicza 4
26-660 Wsola/Jedlińsk

www.kratki.com
+48 48 338 44 88

Date of publication:
05.08.2018