

Fireplace NADIA 13 guillotine

NADIA/13/G

Modern solution for all who care about the ease of use of the fireplace. Hexagonal chamber and excellent combustion parameters are the most important advantages of this model.



Technical Specifications

Rated output (kW)	13,0
Range of heating power (kW)	6.0 - 16.5
Efficiency (%)	81,0
Exhaust outlet diameter (mm)	200
Complies with Ecodesign criteria	Yes
Designed for heat recovery unit	Yes
Fuel type	recommended seasoned hardwood with moisture $\leq 20\%$
Weight (kg)	284,0
CO emission (at 13% O ₂) \leq given in %	0,09
Flue gas temperature (°C)	240,0
Max log length (cm)	40
Emission of dust (mg/Nm ³)	37,0
Compliance with BlmSchV 2 standard	Yes
The energy efficiency index EEI	106,71
The minimum active field of exhaust grilles (cm ²)	≥ 900
The minimum active field of inlet grilles (cm ²)	≥ 700
Glazing type	straight
Opening of the doors	lift up

Material	steel
Width (cm)	93,60
Height (cm)	154,70
Depth (cm)	47,50
External air inlet	Yes
The liner of the combustion chamber	Yes
Ashpan	No
Decorative printed glass	Yes

Features

MAXIMUM USE OF ENERGY

The body and the front of the insert are resistant to high temperatures thanks to the high quality steel used in production.

Efficient burning process and maintaining of temperature to keep the warmth for longer thanks to lining of combustion chamber with Acumotte - heat accumulating material which raises the temperature in the combustion chamber.

Combustion of fuel particles thanks to deflector, which extends the exhaust gas path.

Air supplied from outside only thanks to built-in an external air inlet fi 125 mm. Air adjustment with just one regulator which prevents from improper usage.

Triple air system of combustion chamber: primary air-cerdirected to combustion plate; secondary air supplied by the holes located in the back wall. Additionally, the system of air clean glass has been applied (curtain air).

The cleanliness of combustion chamber thanks to hexagonal hearth.

SAFETY AT THE HIGHEST LEVEL

Perfect tightness thanks to the solid welds made in a noble gas shielding.

All steel elements are laser cut and bent on CNC bending machines.

Insert's front equipped with a heat resistant ceramics that withstands temperatures up to 800°C.

ECOLOGICAL COMBUSTION

The unit meets the requirements of **Ecodesign** standards and the restrictions of the **BImSchV 2** standard, which determines the maximum CO emission.

CONVENIENT TO USE

Grateless fireplace insert - full combustion on the dust what means that firewood burns into fine ash

at minimum amount. Obtained thermal energy from firewood is exploited to the maximum.

Reduced soot deposition through a system of pure glass (air curtain).

The door of the insert works in the lift up system - the window is lifted up. This system was built based on the counterweight - the steel cable pulley works in guides on two ball bearings, thanks to which the weight of the door is distributed evenly. They move on fireproof bearings along the sliding guides mounted in the frame, which guarantees their light, quiet and trouble-free operation.

Movement of the door runs a few millimetres away from the body, which prevents damage to the seal. Lockable doors are pressed with great force into the frame, thanks to which the furnace is completely sealed.

Thanks to the raised and lowered door, you can load the right amount of wood at a time. An additional mechanism that allows the side windows to be opened, making them easier to clean and to keep the furnace clean.

It can be used in a various mounting conditions thanks to adjustable legs and movable fumes outlet with 360° regulation.

MODERN DESIGN

Decorative, heat-resistant ceramics that can withstand temperatures up to 800°C. It gives a fireplace a modern and elegant look, visually enlarges the front of the insert.

Elegant and comfortable handle.

Technical drawing

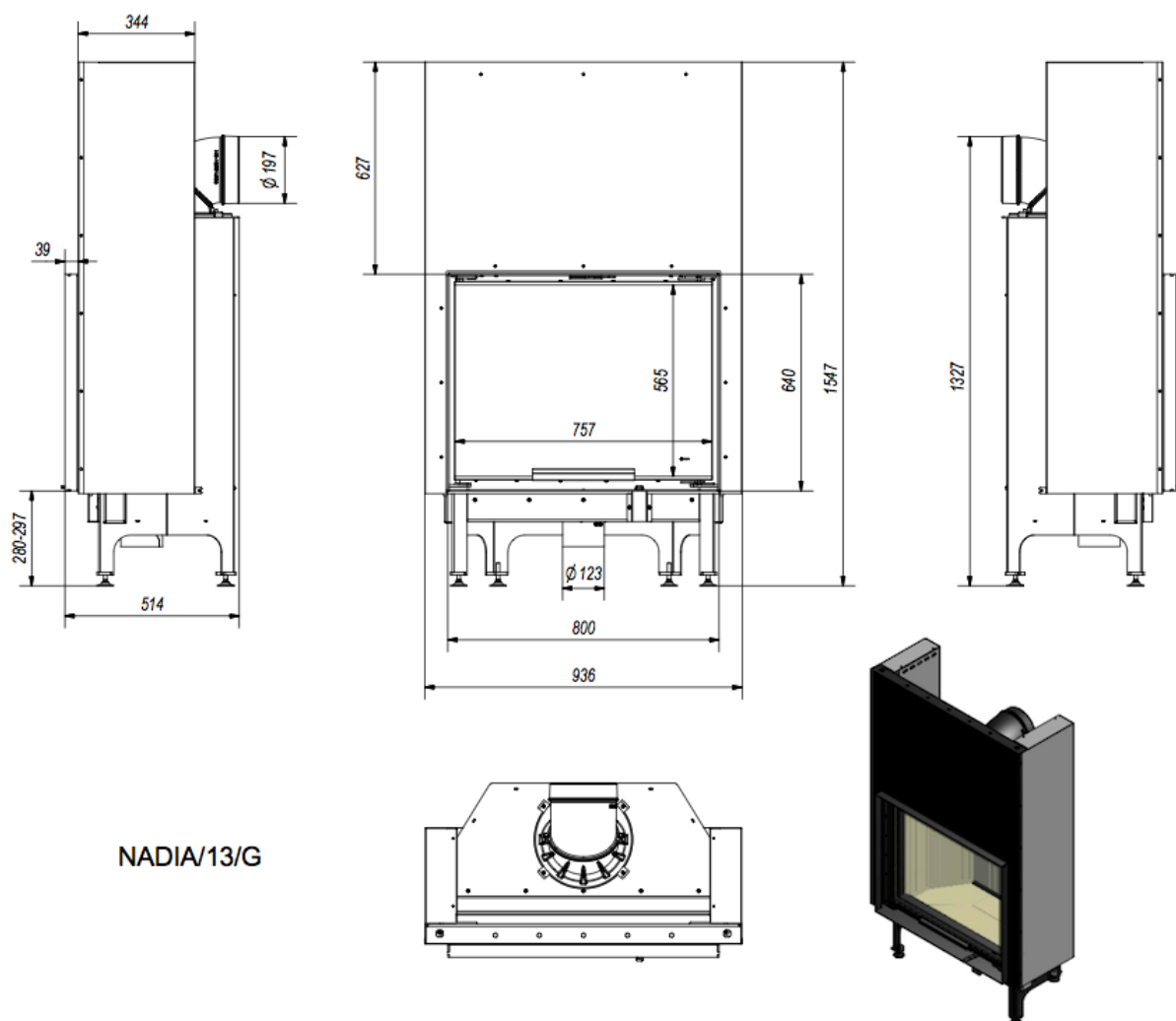

NADIA/13/G

Additional options

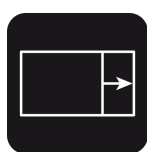

Spring for door shutting
Spring for door shutting - automatically closes the door.

200,00 zł

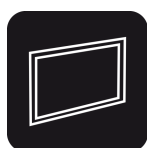





Steel frame for NADIA 13 guillotine
Modern steel decorative frame for the fireplace insert Nadia 13 guillotine.

480,00 zł



Podstawa pod wkład NADIA
Nogi pod wkład NADIA umożliwiają stabilne i bezproblemowe ustawienie wkładu kominkowego, możliwość regulacji wysokości.

123,00 zł

	<p>Steel pipe 200/1m</p> <p>Exhaust pipe designed for connecting wood-fired fireplace inserts an the existing flue pipes.</p>	99,00 zł
	<p>Steel pipe 200/0.5m</p> <p>Exhaust pipe designed for connecting wood-fired fireplace inserts an the existing flue pipes.</p>	68,00 zł
	<p>Movable elbow 200/90</p> <p>Adjustable elbow up to 90°, 3-segment, diameter: 200 mm.</p>	98,00 zł
	<p>The passage from the pipe system Ø 200</p> <p>The passage from the pipe system to the ceramic chimney Ø200.</p>	119,00 zł

Warranty

Wszystkie produkty dostępne na www.kratki.com są fabrycznie nowe, wolne od wad fizycznych i prawnych oraz zostały legalnie wprowadzone na rynek polski. Producent udziela 5 lat gwarancji od momentu zakupu wkładu na jego sprawne działanie. Wyłożenie ceramiczne objęte jest gwarancją na okres 2 lat od momentu zakupu wkładu. Uszczelnienia kominka objęte jest gwarancją na okres 1 roku od momentu zakupu wkładu. Gwarancją nie jest objęta: ceramika żaroodporna. Zastosowanie wkładu kominkowego, sposób podłączenia do komina oraz warunki eksploatacji muszą być zgodne z instrukcją obsługi.

Return

Klient będący Konsumentem, który zawarł Umowę sprzedaży, może w terminie 14 dni odstąpić od niej bez podawania przyczyny. Bieg terminu na odstąpienie od Umowy sprzedaży rozpoczyna się od chwili objęcia Towaru w posiadanie przez Klienta lub wskazaną przez niego osobę trzecią inną niż przewoźnik. Oświadczenie można złożyć na formularzu, którego wzór został zamieszczony przez Sprzedawcę na Stronie Internetowej Sklepu pod adresem: **formularz odstąpienia**.



Kratki.pl Marek Bal
ul. W. Gombrowicza 4
26-660 Wsola/Jedlińsk

www.kratki.com
+48 48 338 44 88

Date of publication:
27.07.2018
